

# Intellectual Property Right Declartion

All not admitted to copy the technology or appearance of our product. If this phenomeno happened,we will inwestigatethe legal liability according to the “Intellectual Property Right”.

**NOTE:**Not dismantle without permit of the manufactory!

# CONTENTS

1. Description of the Lensmeter and Safety Notes .....	1
2. Configuration .....	2
3. Operating Procedures .....	6
4. UV transmittance Measurement .....	17
5. Specifications .....	18
6. Maintenance .....	19
7. Accessories .....	21

# **Description Of The Lensmeter**

## **1. Description Of The Lensmeter**

This auto lensmeter is used for measuring single vision lenses, bifocal (trifocal) lenses, Progressive Power Lenses (PPL) and Contact Lenses (CL).

The display unit utilizes a full-graphic LCD, displaying measured values of right-eye and left-eye lenses at one time, and graphically showing the alignment condition in the shape of a target.

The menu is simple and clear. Icons are conveniently located on the screen, with touch screen, built-in UV testor.

## **2. Safety Notes**

- (1) Be careful when you carry the instrument, strong shock may damage the instrument.
- (2) Make sure to place the instrument in a horizontal and stable place.
- (3) Avoid using the instrument in a place exposed to direct sunlight or near incandescent light.
- (4) Don't place the instrument in the following environment: extremely hot or cold, damp and dirty. Such environments produce adverse effect on the internal parts of the instrument.
- (5) Clean the instrument regularly in order to make the measurement work exactly. After use, turn off the power and pack dust cover.
- (6) Be sure that the nose slider on the left of the instrument.
- (7) If you hear abnormal sound on the internal. Maybe something wrong with the instrument. Please contact your authorized distributor or manufacturer.

## **3. Installation**

- (1) Check accessories  
After unboxing the box, be sure to find all accessories.
- (2) Connect power cord  
Please connect the power cord to the power inlet in the back of instrument. (machine must be earthed)
- (3) After turn on power switch, make sure the instrument is in normal condition.

# USER'S MANUAL

## 8. Measuring Contact Lenses (CL)

(1) Change the nosepiece to the for the contact lens.

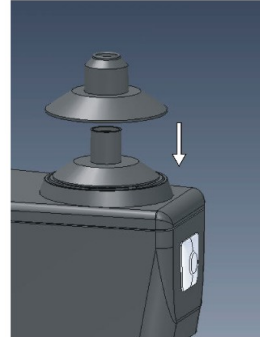

(2) Establish the CL measurement mode as shown.

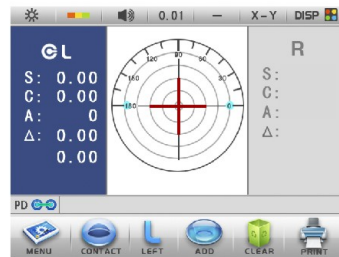

(3) Set the CL

Place the lens on the nosepiece with the convex side up.

NOTE: Hold the CL with tweezers.

Be careful not to damage the lens, only use tweezers with round tips.

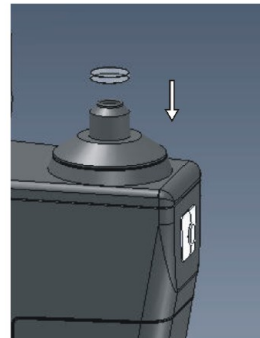

(4) Align the target

(5) Press the Read button

(6) Press the Mode button, the mode returns to the normal measurement mode.

NOTE: Measure the contact lens as quickly as possible so that the lens surface does not become dry.





## 5. Measuring bifocals or trifocals

(1) Bring the distance part onto the nosepiece.

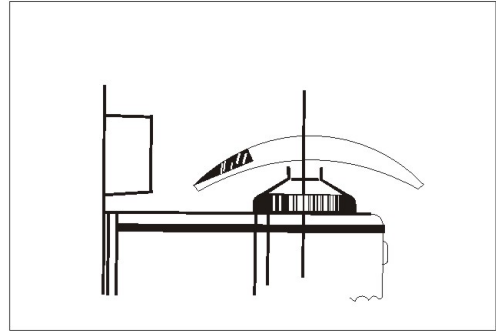

(2) Measuring the distance power.

After the shape of the changes from a circle to a cross line, press the read button. The measured data for distance will be fixed.

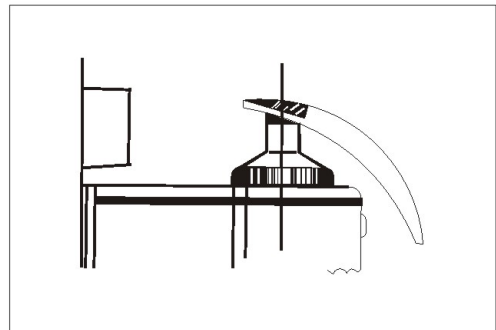

(3) Measuring the addition power (ADD)

pull the lens toward yourself to bring the near portion onto the nosepiece. press ADD button, the ADI appears on the display. when the shape of the target changes from a circle to a cross line, press the Read button. The measured data for near portion will be fixed. For bifocals, the measurement is completed at this point. For trifocals, the measurement is just as the same steps.

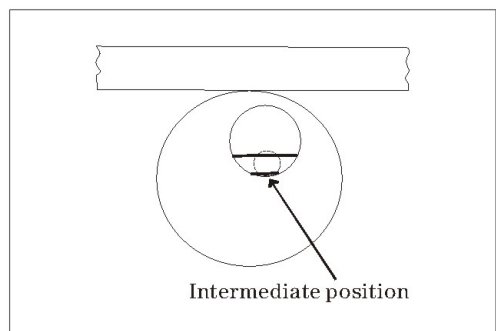

## USER'S MANUAL

(4) Bring the near portion onto the nosepiece.

Press ADD button, the display appears Ad2.

After the shape of the target changing from a circle to a cross line, press Read button.

The measured data for near position will be Fixed.

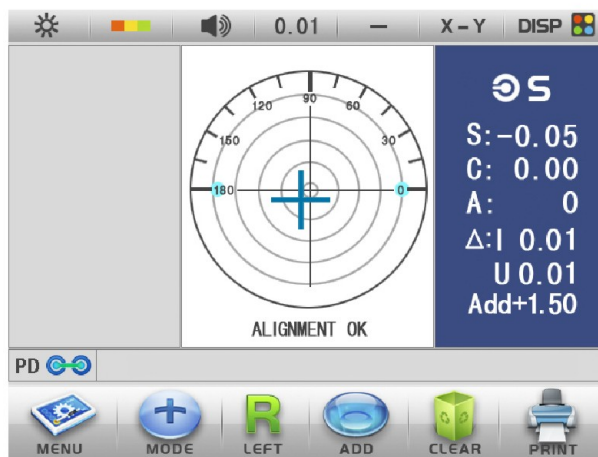

## 6. Measuring Progressive Power lenses(PPL)

Press Mode change button, the PPL measurement mode will be established.

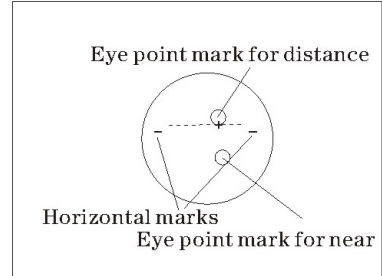

### • Measuring Uncut Lenses

Using the manufacture's specific eye point marks, the lens should be placed with its horizontal marks paralleled to the table. The near position is inside. The display appears ADD and measured data. Bring the distance part onto the nose piece, then move the lens slowly.

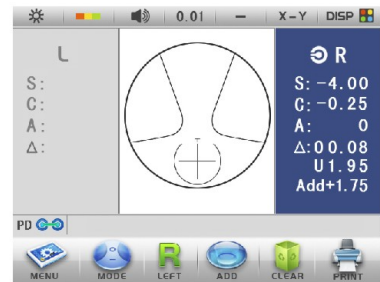

### • Measuring Mounted Lenses

- (1) Set the lens.
- (2) Bring the distance part onto the nose piece and place upper-third of the lens.

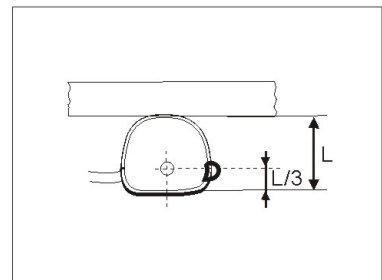

### (3) Bring The Target Onto The Guide Line

Move the lens sideways to bring the target onto the middle of the guide line. When the target changes to cross(+) or +, press read Button, the distance data is fixed.

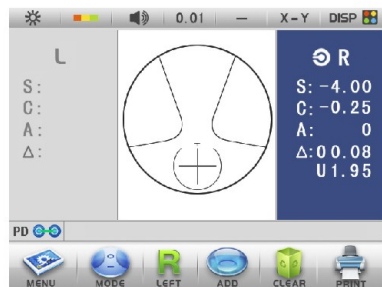

# USER'S MANUAL

(4) Measuring distance part, manual or automatic memory data for distance part.

(5) 'PUSH' sign appears, it means slow motion lens according to arrow direction, starts to measure progressive region. Meanwhile the screen demonstrates the ADD histogram.

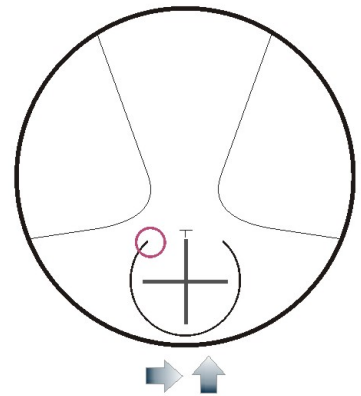

(6) Search for the point that the ADD degree change situation. When ADD degree is in maximum value, press the memory key, finish this measuring.

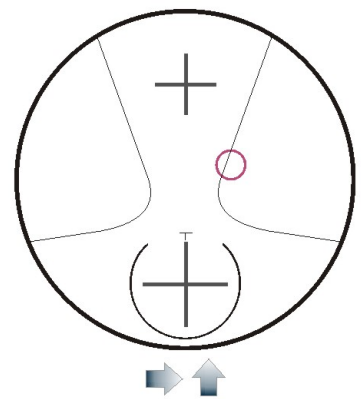

## NOTE:

A: In gradually moving lens process, uncut lens' nearsighted partial edge or farsighted partial edge, possibly some lens prism is big, surpassing instrumental measuring scope, the instrument will demonstrate 'over prism', this has not related, when measuring, push the lens toward medial direction.

B: The ADD of some lens is increasing consequently, sometimes out the range of near portion. If measuring these lens, the biggest ADD is out the range of near portion. Press the READ button when the icon appears in the near portion.

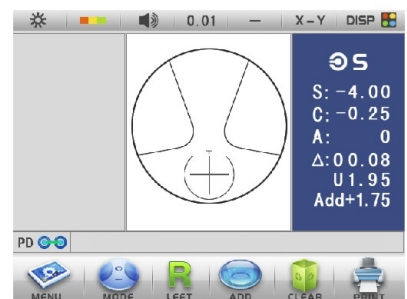

## 7. Measuring Prismatic Lenses

Measuring mounted prismatic lenses

- (1) Mark the pupil center. Instruct the customer to wear the spectacles and look straight, Mark the pupil center on each lens.

NOTE: The mark should be smaller than 1mm in diameter, the mark is too big it may interfere with the measurement.

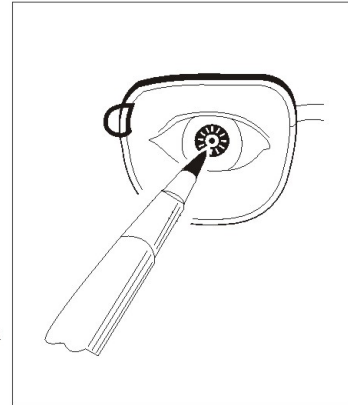

- (2) Specify the lens side, press L/R button to specify right eye lens or left-eye lens.

- (3) Choose the prism indication type

Rectangular coordinates  $\Delta$ : 1 5.00

D 0.03

Polar coordinates  $\Delta$ : 1.00

0

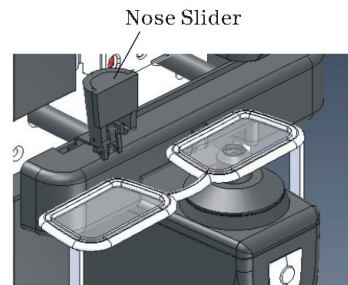

- (4) Set the lens

Place the lens on the nosepiece as shown with the convex side up.

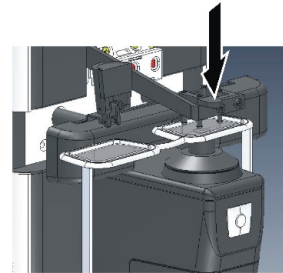

- (5) Fix the lens with the lens holder.

- (6) Bring one of the eye point marks on the center of nosepiece.

- (7) Press the Read button.

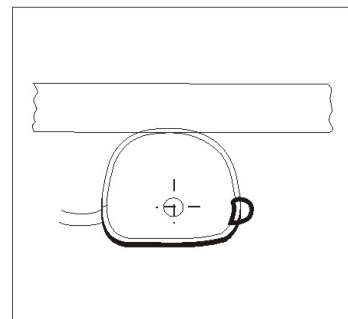

## USER'S MANUAL

---

### 9. Marking On The Optical Center

This is the method used to mark the lens in order to specify the optical center and the horizontal direction for mounting it to a frame.

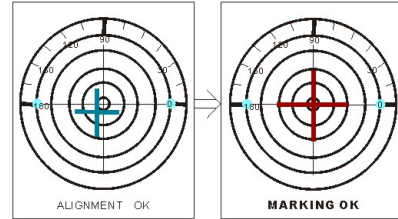

- (1) Move the lens more to align the target to the center cross so that the shape of the target changes from a cross line to a large cross.
- (2) Set the axis to the prescribed value. While watching the axis value on the display, rotate the lens until the value shows the prescription. If the large cross changes back to a cross line, align again.
- (3) Set the prismatic lens to the prescribed value. Press MENU button and make the prismatic value same as the prescribed prism value. Choose rectangular coordinates, "O" means base out, "I" means base in, "D" means base down and "U" means base up. Put the measuring lens onto lens table, rotate it gently and make the direction same as the prescribed value.
- (4) Mark the lens. Press down the marking lever to mark the lens. Three points in a line parallel to the lens table will be marked. To remove the lens, raise the Lens holder lever until it clicks.

**NOTE:** Do not touch the markings as the ink is easy to smear.



# UV Transmittance Measurement

- (1) Turn on power.
- (2) Take out the UV measuring part cover.
- (3) Press UV button.
- (4) Set the lens on the place of UV measuring part.
- (5) The measurement appears in the screen.

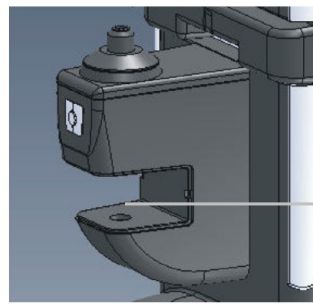
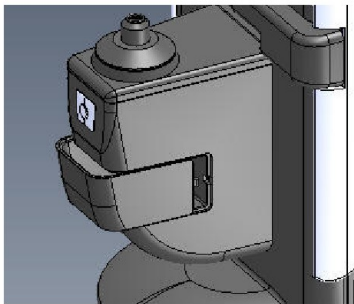

Measuring window

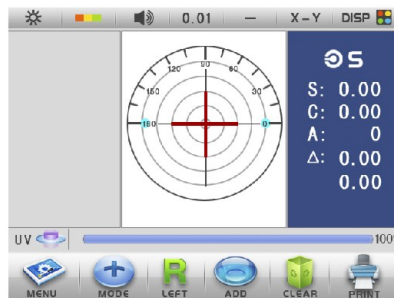

**NOTE:**

- A: When no lens in the place, UV transmittance rate is 100%. If not, wipe the two window of measuring box with a dry cloth.
- B: Not place the lens inside the measuring part before pressing UV button.
- C: It will be automatic closed after two minutes when you don't use the UV measurement after pressing UV button.
- D: In order to protect and save the life of UV measuring part, please close this function after measuring lens.



## Specifications

<b>Measure scope</b>	
Sphere	0~±25D(0.01/0.12/0.25D steps)
Cylinder	0~±9.99D(0.01/0.12/0.25D steps)
Axis	0~180(1°step)
Addition	0~±9.99D(0.01/0.12/0.25D steps)
Prism	0~15 (0.01/0.12/0.25△ steps)
<b>Measurement Mode</b>	
Measuring mode	lens auto recognition contact lens
Pupil Distance	45~90mm, 0.25mm steps
Cylinder	+,+/-,-
Prism	X-Y,P-B
Measuring speed	0.1second
Lens diameter	⌀20~108mm
Contact lens	Soft/Hard lens
ABBE	30~60
Display	5.6"LCD/TFT
Print	Thermal Printer
Power supply	100~240V 50/60Hz
Dimension	222*161*372mm
Package	530*330*370mm
Weight	Approx.5kg

# Maintenance

## 1. Replacing Printer Paper

- (1) The cover opens by pressing the O mark on the top of the cover.
- (2) Head up the green control stick.
- (3) Make sure the paper is not jagged, but cut clearly.
- (4) Set the new printer paper.
- (5) Pass the printer paper through the paper outlet of the printer cover. head down the green control stick and close the cover.

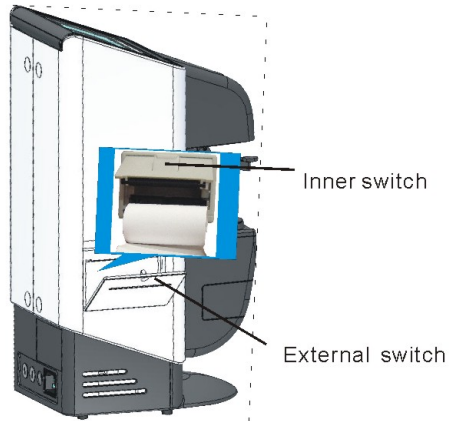

## 2. Replacing Fuses

When the instrument does not normally turn on, the fuses may be blown. replace them with spare fuses provided

- (1) Turn off the power.
- (2) Disconnect the power cord from the wall outlet.
- (3) Remove the fuse holder.
- (4) Replace the fuses.
- (5) Set the fuse holder back into position.

## 3. Cleaning Exterior

- (1) When the exterior parts of the instrument become dirty, wipe with a dry and soft cloth. For stubborn dirt, immerse the cloth in a neutral detergent, wring well and wipe. Finally wipe off with a dry and soft cloth.

**CAUTION:** Never use an organic solvent such as paint thinner to clean the instrument as it may ruin the surface of the instrument.

## Configuration

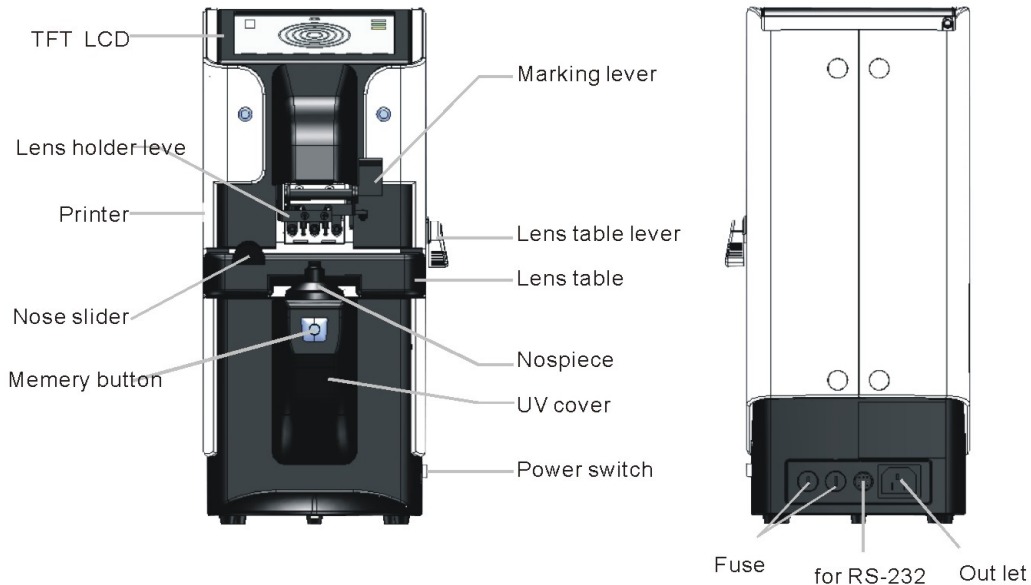

- **Read Button:** Button for reading data. This makes the measured data on the display fixed so that they will be saved in memory.
- **Protective cap:** Used for anti-dusty, this must be taken away before measuring.
- **Nosepiece:** Used to place the lens on, the base point for measurement when measuring contact lenses (CL), this must be replaced with the special one for CL measurement.
- **Lens Holder Lever:** Used to move the lens holder to fix the lens to lift it once and lower it gently, or to remove the lens to lift it until it clicks.
- **Nose Slider:** Used to measure PD of spectacles. When the nose pads of the spectacles are placed astride, it automatically detects the lens sides and calculates the distance between the right and left 'read' positions as the PD value.
- **Pilot Lamp:** Power ON state: Lt.
- **Marking Lever:** Used for marking lenses. To do so, push the lever down.
- **Lens Table Lever:** Used to move the lens table back and forth.  
this part.
- **Printer:** Used to print measured data.
- **UV measuring part cover**

NOTE: The display will automatically turn OFF when certain time passes without any button operation, the auto OFF time limit can be specified in the MENU DISPLAY. To recall the ON state, press any button.

## USER'S MANUAL

---

(2)Cleaning protective glass:If is necessary to regularly clean dust and dirt from the protective glass underneath the nosepiece.Lift up to remove the nosepiece and clean the protective glass.blow off any dust on the glass with a blower brush.if it is still dirty,wipe gently with a lens cleanin paper.

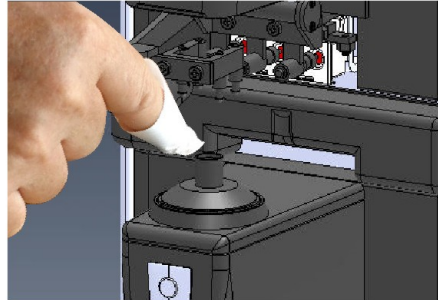
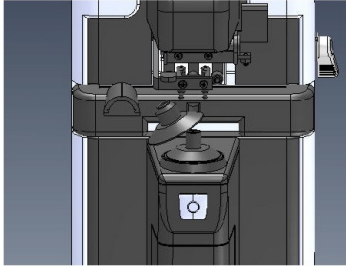

## 4. Ink Refilling

When markings become faint,please refilling the ink box.

(1)Lean gently or put the lensmeter down.Rotate the ines table lever.Don't touch the marking lever. Make sure the ink box is in the best position.

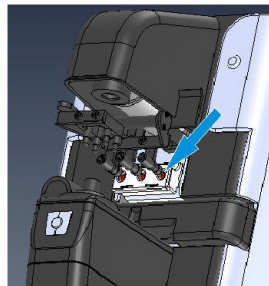

(2)Carefully immit ink into ink box's three holes,three to four drops hole is ok.

NOTE:Do not drop to other spots, if that,please use the lint ball to dip the liquid(alcohol)to clean.

## **Accessories**

1. Printer paper
2. Spare fuses
3. Dust cover
4. Glasses cloth
5. Protective cap
6. Nosepiece
7. Nosepiece(for contact lens)
8. User's manual
9. Ink
10. Power cord

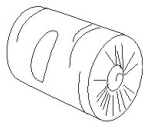

(1)

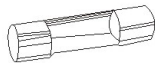

(2)



(3)



(4)



(5)

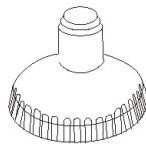

(6)

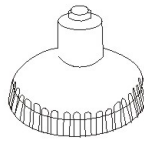

(7)



(8)

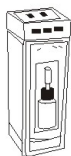

(9)



(10)

## Measurement Display

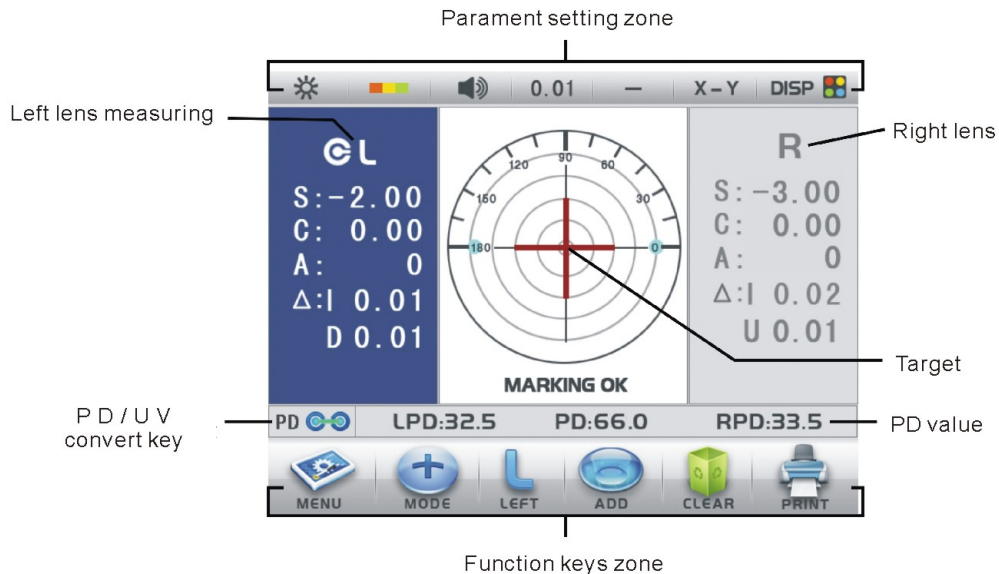

### Setting Signs

0.01,0.12,0.25 :Steps

+/-,+,-:CYL reading direction

30.40.50.60:abbe value

**Target:**Shows the measuring point while lens is on the nosepiece.the shape of the target changes with sligment.

**O:**out of center

**+**:in the center within 0.5Δ

**⊕**:aligned to the center(marking point)

**R/L sign:**Appears when the lens side is specified,and wales below each show the measured data of the side.

**"S"sign:**Shows that the measured lens is single.

**PD values:**Show both monocular PD(LPD,RPD)and total pd of spectacles.

**Icons:**These show the functions of buttons on their sides.



# USER'S MANUAL

## Menu Display

### INTRODUCTION OF FUNCTION KEYS:



enter to set items



for bifocal/trifocal lens



print the result



single lens



progressive



automatic recognition of  
single/progressive lens



contact lens



convery R/L



clear data



PD measurement



UV measurement

### INTRODUCTION OF FUNCTION KEYS:



..... for cylinder convert



..... for sound volume



..... accuracy step



..... for prism



..... for setting brightness



..... for color choose(bray/navy/bl)



..... for display



# USER'S MANUAL



## MENU DESCRIPTION:

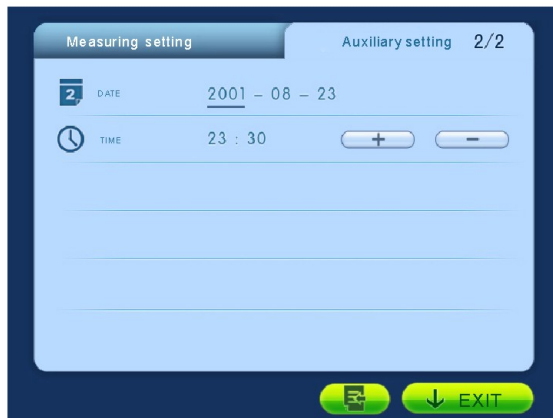

## Operation procedures

### 1. preparation

1. Connect the power cord to power inlet.
2. Connect the power cord into the wall outlet.
3. Turn on the power.

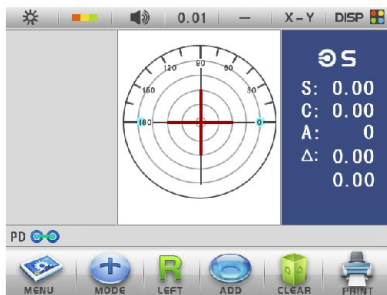

#### NOTE:

- Do not turn on the power with the lens on the nosepiece, if the lens is not on the nosepiece before the measurement display appears 'DATA ERROR'. Remove the lens and turn on the power again.
- The same when protective cap on nosepiece, take it away and try again.
- Check if the nose slider is slide on the left end, if not 'PD ERROR' appears.

### 2. Lens settings

1. Specify the lens side
  - When not need to measure PD values, check it if the nose slider is flipped upon the left. press L\R button to specify right-eye or left-eye lens.
  - When measuring PD, the position of the nose slider will be taken for the R\L judgement and R\L button operation will be ignored. it can measure LPD, RPD or the distance between the optical centers.  
Not need to specify right-eye lens or left-eye lens, the screen display "S".

Nose Slider

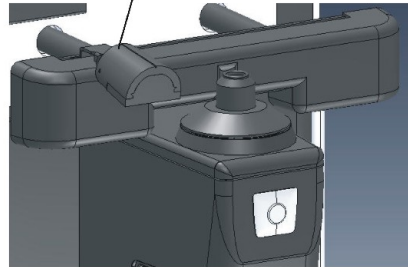

## 2. Set The Lens

Place the measuring lens on the nosepiece with the convex side up.

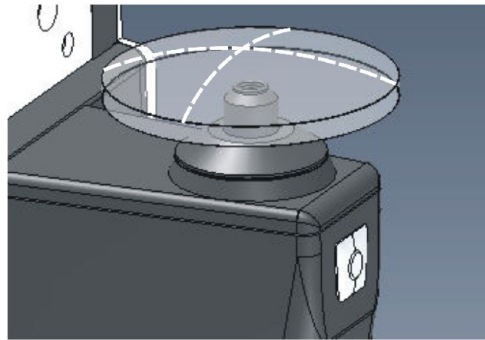

## 3. Fix The Lens

Raise the lens holder to its uppermost, then lower it slowly to fix the lens.

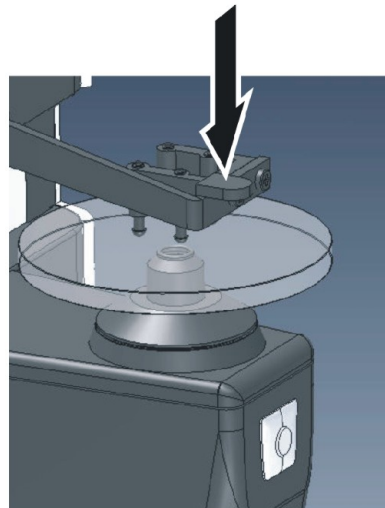

## 3. lens measurement

### 1. Measuring Single Vision Lenses

#### (1) Bring the target to the center

Move the lens to bring the target "O" close to the center of the alignment circle.

(2) When the target comes within a range of  $0.5\Delta$  from the center, the shape of the target changes to a cross line. move the lens to align the target, the shape of the target changes to a large cross. there are two measuring ways.

A. press the read button, the measured data will be fixed.

pressing +/- alternates the cylinder reading direction.

pressing clear button, the measurement repeat again.

B. When the "AUTO BEAD" parameter is set, data will be automatically fixed after the target is centered, just as the read button is pressed, to repeat the measurement, press Clear button first, perform alignment and press the read button again.

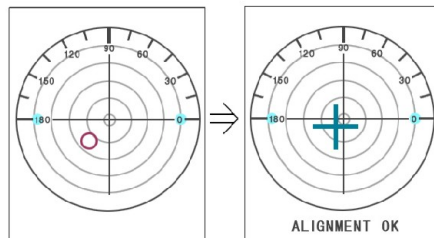
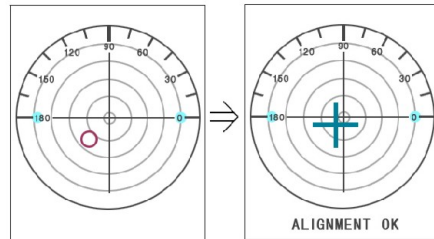

### 2. measuring mounted lenses.

regular measurement.

#### (1) press "L/R" button, bring the target to the center.

move the lens to the target "O" close to the center of the alignment circle. when the target comes within a range of  $0.5\Delta$  from the center, the shape of the target changes to a cross line. move the lens to align the target "O" to the center cross so that the shape of the target changes from a cross line to a large cross. press the read button and the measured data will be fixed.

(2) press L/R button, measure the other lens, repeat the same steps as the first lens.

## PD measurement

Alternate L/R lens by moving nose slider.

(1) Move the lens table until it touches the bottom of the frame and move nose slider to the center of mounted lenses. move the lens to bring the target close to the center of the alignment circle when the target comes within a range of  $0.5\Delta$  from the center. the shape of the target changes to a crossline.

Move the lens to align the target to the center cross so that the shape of the target changes from a cross line to a large cross. press read button, the measured data will be fixed.

(2) Measuring the other lens, repeat the same steps as the first lens.

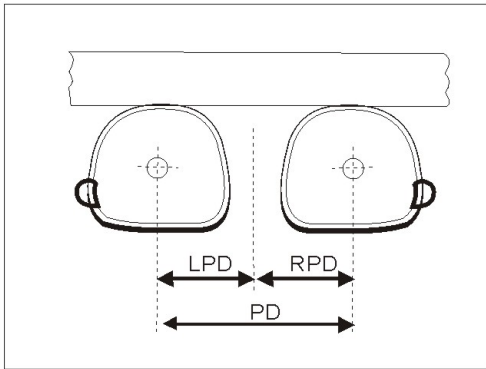

### 3. High refractive index lens measurement

before measuring high refractive index lens, set abbe value in the menu display.

correspondingly to the ready measured lens. then begin to measure in the measurement display. the measuring data in the display is after.

4. Press print button to get value.

AUTO LENSMETER	
NAME:	
DATE:2003/12/06 17:52	
<SINGLE>	
SPH:+2.50	
CYL:0.00	AXS:0
PSM:I 0.36	D 0.35
AD1: 1.00	AD2:2.00

Single Vision Lenses

AUTO LENSMETER	
NAME:	
DATE:2003/12/06 17:52	
<R>	<L>
SPH:-2.50	+2.50
CYL:0.00	0.00
AXS:0	0
PSM:I 0.40	O 0.36
PSM:D 0.38	U 0.36
AD1: 2.00	2.00
AD2:1.00	1.00
RPD:32.0	LPD:32.0
PD:64.0	

R/L lenses

# Auto Lensmeter **User' s Manual**

